



CORDLESS HEDGE TRIMMER – TOOL ONLY

24 VOLT MAX* | 7-INCH

OPERATOR'S MANUAL

A Division of Snow Joe®, LLC

Model 24V-SSEG-CT-RM

Form No. SJ-24V-SSEG-CT-RM-880E-M-V1

THANKS FOR YOUR PURCHASE OF A REMANUFACTURED PRODUCT.

To make sure you get the most out of your product, be sure to register online at

sunjoe.com

to enjoy full product support.

PASTE UPC LABEL HERE



CORDLESS HEDGE TRIMMER – TOOL ONLY

24 VOLT MAX* | 7-INCH

OPERATOR'S MANUAL

A Division of Snow Joe®, LLC

Model 24V-SSEG-CT-RM

Form No. SJ-24V-SSEG-CT-RM-880E-M-V1

IMPORTANT!

Safety Instructions

All Operators Must Read These Instructions Before Use

Always follow these safety guidelines. Failure to do so may result in serious bodily injury or death.

General Safety WARNINGS!

Read all safety warnings and all instructions. Failure to follow the warnings and instructions may result in electric shock, fire and/or serious injury.

Save all warnings and instructions for future reference.

The term “power tool” in the warnings refers to your mains-operated (corded) power tool or battery-operated (cordless) power tool.

⚠️WARNING! This unit can be dangerous! Careless or improper use can cause serious injury.

⚠️WARNING! The rotating blades can cut you. Keep hands and feet away from the blades and the cutting area.

Retain this manual for future reference and reread it at the start of each trimming season.

⚠️WARNING! This battery-operated power tool must be recharged only with the specific charging unit for the battery. A charging unit that may be suitable for one type of battery may create a risk of fire when used with another battery type.

- Avoid accidental starting.
- When the tool is not in use, keep it away from other metal objects.
- Before operating the tool, read the entire manual carefully and make sure you know how to switch the tool OFF in an emergency.

Work Area Safety

1. **Keep work area clean and well lit.** Cluttered and dark areas invite accidents.
2. **Do not operate power tools in explosive atmospheres, such as in the presence of flammable liquids, gases or dust.** Power tools create sparks which may ignite the dust or fumes.

3. **Keep children and bystanders away while operating a power tool.** Distractions can cause you to lose control.

Electrical Safety

1. **Power tool plugs must match the outlet. Never modify the plug in any way. Do not use any adapter plugs with earthed (grounded) power tools.** Unmodified plugs and matching outlets will reduce risk of electric shock.
2. **Avoid body contact with earthed or grounded surfaces such as pipes, radiators, ranges and refrigerators.** There is an increased risk of electric shock if your body is earthed or grounded.
3. **Do not expose power tools to rain or wet conditions.** Water entering a power tool will increase the risk of electric shock.
4. **Do not abuse the cord. Never use the cord for carrying, pulling or unplugging the power tool. Keep cord away from heat, oil, sharp edges or moving parts.** Damaged or entangled cords increase the risk of electric shock.
5. **When operating a power tool outdoors, use an extension cord suitable for outdoor use.** Use of a cord suitable for outdoor use reduces the risk of electric shock.
6. **If operating a power tool in a damp location is unavoidable, use a residual current device (RCD) protected supply.** Use of an RCD reduces the risk of electric shock.
NOTE: The term “residual current device (RCD)” may be replaced by the term “ground fault circuit interrupter (GFCI)” or “earth leakage circuit breaker (ELCB)”.
7. Battery charger is for indoor use only. Only charge this battery-powered tool indoors.
8. If the battery charger cable is damaged, please call the Snow Joe® + Sun Joe® customer service center at 1-866-SNOWJOE (1-866-766-9563).

Personal Safety

1. **Stay alert. Watch what you are doing and use common sense when operating a power tool. Do not use the power tool while you are tired or under the influence of drugs, alcohol or medication.** A moment of inattention while operating power tool may result in serious personal injury.
2. **Use personal protective equipment. Always wear eye protection.** Protective equipment such as safety glasses, a dusk mask, non-skid safety shoes, hard hat or hearing protection used for appropriate conditions, will reduce the possibility of personal injuries.

3. **Prevent unintentional starting. Ensure the switch is in the off-position before connecting to power source and/or battery pack, picking up or carrying the tool.** Carrying power tools with your finger on the switch or energising power tools that have the switch on invites accidents.
4. **Remove any adjusting key or wrench before starting the power tool on.** A wrench or a key left attached to a rotating part of the power tool may result in personal injury.
5. **Do not overreach. Keep proper footing and balance at all times.** This enables better control of the power tool in unexpected situations.
6. **Dress properly. Do not wear loose clothing or jewelry. Keep your hair, clothing and gloves away from moving parts.** Loose clothes, jewellery or long hair can be caught in moving parts.
7. **If devices are provided for the connection of dust extraction and collection facilities, ensure these are connected and properly used.** Use of dust collection can reduce dust-related hazards.

Power Tool Use and Care

1. **Do not force the power tool. Use the correct power tool for your application.** The correct power tool will do the job better and safer at the rate for which it was designed.
2. **Do not use the power tool if the switch does not turn it on and off.** Any power tool that cannot be controlled by the switch is dangerous and must be repaired.
3. **Disconnect the plug from the power source and/or the battery pack from the power tool before making any adjustments, changing accessories, or storing power tools.** Such preventive safety measures reduce the risk of starting the power tool accidentally.
4. **Store idle power tools out of the reach of children and do not allow persons unfamiliar with the power tool or these instructions to operate the power tool.** Power tools are dangerous in the hands of untrained users.
5. **Maintain power tools. Check for misalignment or binding of moving parts, breakage of parts and any other condition that may affect the power tool's operation. If damaged, have the power tool repaired before use.** Many accidents are caused by poorly maintained power tools.
6. **Keep cutting blades sharp and clean.** Properly maintained cutting blades with sharp edges are less likely to bind and are easier to control.
7. **Use the power tool, accessories and tool bits etc. in accordance with these instructions, taking into account the working conditions and the work to be performed.** Use of the power tool for operations different from those intended could result in a hazardous situation.

Battery Tool Use and Care

1. **Recharge only with the charger specified by the manufacturer.** A charger that is suitable for one type of battery pack may create a risk of fire when used with another battery pack.
2. **Use power tools only with specifically designated battery packs.** Use of any other battery packs may create a risk of injury and fire.
3. **When battery pack is not in use, keep it away from other metal objects, like paper clips, coins, keys, nails, screws or other small metal objects, that can make a connection from one terminal to another.** Shorting the battery terminals together may cause burns or a fire.
4. **Under abusive conditions, liquid may be ejected from the battery; avoid contact. If contact accidentally occurs, flush with water. If liquid contacts eyes, additionally seek medical help.** Liquid ejected from the battery may cause irritation or burns.

Service

1. **Have your power tool serviced by a qualified repair person using only identical replacement parts.** This will ensure that the safety of the power tool is maintained.

Hedge Trimmer Safety Warnings

1. **Keep all parts of the body away from the cutter blade. Do not remove cut material or hold material to be cut when blades are moving. Make sure the switch is off when clearing jammed material. Blades coast after turn off.** A moment of inattention while operating the hedge trimmer may result in serious personal injury.
2. **Carry the hedge trimmer by the handle with the cutter blade stopped.** Proper handling of the hedge trimmer will reduce possible personal injury from the cutter blades.
3. **Hold the power tool by insulated gripping surfaces only, because the cutter blade may contact hidden wiring or its own cord.** Cutting blades contacting a "live" wire may make exposed metal parts of the power tool "live" and could give the operator an electric shock.
4. **DANGER – Keep hands away from blade(s). Contact with blade(s) will result in serious personal injury.**

Battery & Charger

Safety Instructions

NOTE: This unit is the tool only. The battery and the charger are not included. They must be purchased separately. Model 24V-SSEG-CT-RM is compatible with the iON+ 24V System batteries and chargers. See page 15 for more information.

We pay a great deal of attention to the design of every battery pack to ensure that we supply you with batteries that are safe, durable and have a high energy density. The battery cells have a wide range of safety devices. Each individual cell is initially formatted and its electrical characteristic curves are recorded. This data is then used exclusively to be able to assemble the best possible battery packs.

Despite all the safety precautions, caution must always be exercised when handling batteries. The following points must be obeyed at all times to ensure safe use. Safe use can only be guaranteed if undamaged cells are used. Incorrect handling of the battery pack can cause cell damage.

IMPORTANT! Analyses confirm that incorrect use and poor care of high-performance batteries are the main factors responsible for personal and/or product damage.

⚠️ WARNING! Use only approved replacement batteries; other batteries may damage the power tool and cause it to malfunction, which can lead to serious personal injury.

⚠️ WARNING! Do not use a battery pack or appliance that is damaged or modified. Damaged or modified batteries may exhibit unpredictable behavior resulting in fire, explosion or risk of injury.

Do not modify or attempt to repair the appliance or the battery pack except as indicated in the instructions for use and care.

Have your battery pack serviced by a qualified repair person using only identical replacement parts. This will ensure that the safety of the battery pack is maintained.

⚠️ CAUTION! To reduce the risk of injury, charge the iON+ 24V lithium-ion battery pack only in its designated iON+ 24V lithium-ion charger. Other types of chargers present risk of fire, personal injury and damage. Do not wire a battery pack to a power supply plug or car cigarette lighter. Such misuse will permanently disable or damage the battery pack.

- **Avoid dangerous environments** – Do not charge the battery pack in rain, snow or in damp or wet locations. Do not use the battery pack or charger in the presence of explosive atmospheres (gaseous fumes, dust or flammable materials) because sparks may be generated when inserting or removing the battery pack, which could lead to a fire.
- **Charge in a well-ventilated area** – Do not block the charger vents. Keep them clear to allow for proper ventilation. Do not allow smoking or open flames near a charging battery pack. Vented gases may explode.

NOTE: The safe temperature range for the battery is 41°F – 105°F (5°C – 40.5°C). Do not charge the battery outside in freezing weather; charge it at room temperature.

- **Maintain charger cord** – When unplugging the charger, pull the plug, not the cord, from the receptacle to reduce the risk of damage to the electrical plug and cord. Never carry the charger by its cord or yank it by the cord to disconnect it from the receptacle. Keep the cord away from heat, oil and sharp edges. Make sure the cord will not be stepped on, tripped over or subjected to damage or stress when the charger is in use. Do not use the charger with a damaged cord or plug. Replace a damaged charger immediately.
- **Do not use an extension cord unless it is absolutely necessary** – Using the wrong, damaged or improperly wired extension cord poses a risk of fire and electric shock. If an extension cord must be used, plug the charger into a properly wired 16 gauge or larger extension cord with the female plug matching the male plug on the charger. Make sure that the extension cord is in good electrical condition.
- **Check the rated input for the charger before using** – The charger must be plugged into an appropriate receptacle.
- **Use only recommended attachments** – Use of an attachment not recommended or sold by the battery charger or battery pack manufacturer may result in risk of fire, electric shock or personal injury.
- **Unplug charger when not in use** – Make sure to remove battery packs from unplugged chargers.

⚠️ WARNING! To reduce the risk of electric shock, always unplug the charger before performing any cleaning or maintenance. Do not allow water to flow into the charger. Use a Ground Fault Circuit Interrupter (GFCI) to reduce shock hazards.

- **Do not burn or incinerate battery packs** – Battery packs may explode, causing personal injury or damage. Toxic fumes and materials are created when battery packs are burned.
- **Do not crush, drop or damage battery packs** – Do not use the battery pack or charger if they have sustained a sharp blow, been dropped, run over or have been damaged in any way (i.e. pierced with a nail, hit with a hammer, stepped on, etc.).
- **Do not disassemble** – Incorrect reassembly may pose a serious risk of electric shock, fire or exposure to toxic battery chemicals. If the battery or charger are damaged, contact an authorized Snow Joe® + Sun Joe® dealer or call the Snow Joe® + Sun Joe® customer service center at 1-866-SNOWJOE (1-866-766-9563) for assistance.
- **Battery chemicals cause serious burns** – Never let a damaged battery pack contact the skin, eyes or mouth. If a damaged battery pack leaks battery chemicals, use rubber or neoprene gloves to safely dispose of it. If skin is exposed to battery fluids, wash the affected area with soap and water and rinse with vinegar. If eyes are exposed to battery chemicals, immediately flush with water for

20 minutes and seek medical attention. Remove and dispose of contaminated clothing.

- **Do not short circuit** – When battery pack is not in use, keep it away from other metal objects, like paper clips, coins, keys, nails, screws or other small metal objects, that can make a connection from one terminal to another. Shorting the battery terminals together may cause burns or a fire.
- **Store your battery pack and charger in a cool, dry place** – Do not store the battery pack or charger where temperatures may exceed 105°F (40.5°C), such as in direct sunlight or inside a vehicle or metal building during the summer.

Information about the battery

1. For optimum battery performance, avoid low discharge cycles by charging the battery pack frequently.
2. Store the battery pack in a cool place, ideally at 59°F (15°C) and charged to at least 40%.
3. Lithium-ion batteries are subject to a natural aging process. The battery pack must be replaced at the latest when its capacity falls to just 80% of its capacity when new. Weakened cells in an aged battery pack are no longer capable of meeting the high power requirements needed for the proper operation of your cordless hedge trimmer, and therefore pose a safety risk.
4. Do not throw battery packs into an open fire as this poses a risk of explosion.
5. Do not ignite the battery pack or expose it to fire.
6. Do not exhaustively discharge batteries. Exhaustive discharge will damage the battery cells. The most common cause of exhaustive discharge is lengthy storage or non-use of partially discharged batteries. Stop working as soon as the performance of the battery falls noticeably or the electronic protection system triggers. Place the battery pack in storage only after it has been fully charged.
7. Protect batteries and the tool from overloads. Overloads will quickly result in overheating and cell damage inside the battery housing even if this overheating is not apparent externally.
8. Avoid damage and shocks. Immediately replace batteries that have been dropped from a height of more than 3 feet (1 meter) or those that have been exposed to violent shocks, even if the housing of the battery pack appears to be undamaged. The battery cells inside the battery may have suffered serious damage. In such instances, please read the waste disposal information for proper battery disposal.
9. If the battery pack suffers overloading and overheating, the integrated protective cutoff will switch off the equipment for safety reasons.

IMPORTANT! Do not press the ON/OFF switch any more if the protective cut-off has been activated. This may damage the battery pack.

10. Recharge only with the charger specified by the manufacturer. A charger that is suitable for one type of battery pack may create a risk of fire when used with another battery pack.
11. Use appliances only with specifically designated battery packs. Use of any other battery packs may create a risk of injury and fire.
12. Under abusive conditions, liquid may be ejected from the battery; avoid contact. If contact accidentally occurs, flush with water. If liquid contacts eyes, additionally seek medical help. Liquid ejected from the battery may cause irritation or burns.
13. Do not use a battery pack or appliance that is damaged or modified. Damaged or modified batteries may exhibit unpredictable behavior resulting in fire, explosion or risk of injury.
14. Do not expose a battery pack or appliance to fire or excessive temperature. Exposure to fire or temperature above 266°F (130°C) may cause explosion.
15. Follow all charging instructions and do not charge the battery pack or appliance outside of the temperature range specified in the instructions. Charging improperly or at temperatures outside of the specified range may damage the battery and increase the risk of fire.

Information about the charger and the charging process

1. Please check the data marked on the rating plate of the battery charger. Be sure to connect the battery charger to a power supply with the voltage marked on the rating plate. Never connect it to a different mains voltage.
2. Protect the battery charger and its cord from damage. Keep the charger and its cord away from heat, oil and sharp edges. Have damaged cords repaired without delay by a qualified technician at an authorized Snow Joe® + Sun Joe® dealer or call the Snow Joe® + Sun Joe® customer service center at 1-866-SNOWJOE (1-866-766-9563).
3. Electrical plugs must match the outlet. Never modify the plug in any way. Do not use any adapter plugs with grounded appliances. Unmodified plugs and matching outlets will reduce the risk of electric shock.
4. Keep the battery charger, battery pack(s) and the cordless tool out of the reach of children.
5. Do not use the supplied battery charger to charge other cordless tools.
6. During periods of heavy use, the battery pack will become warm. Allow the battery pack to cool to room temperature before inserting it into the charger to recharge.











7. Do not overcharge batteries. Do not exceed the maximum charging times. These charging times only apply to discharged batteries. Frequent insertion of a charged or partially charged battery pack will result in overcharging and cell damage. Do not leave batteries in the charger for days on end.
 8. Never use or charge batteries if you suspect that it has been more than 12 months since the last time they were charged. There is a high probability that the battery pack has already suffered dangerous damage (exhaustive discharge).
 9. Charging batteries at a temperature below 41°F (5°C) will cause chemical damage to the cells and may cause a fire.
 10. Do not use batteries that have been exposed to heat during the charging process, as the battery cells may have suffered dangerous damage.
 11. Do not use batteries that have suffered curvature or deformation during the charging process or those that exhibit other atypical symptoms (gassing, hissing, cracking, etc.).
 12. Never fully discharge the battery pack (maximum recommended depth of discharge is 80%). A complete discharge of the battery pack will lead to premature aging of the battery cells.
7. Store the charger and your cordless tool only in dry locations with an ambient temperature of 41°F – 105°F (5°C – 40.5°C). Store your lithium-ion battery pack in a cool, dry place at a temperature of 77°F (25°C). Protect the battery pack, charger and cordless tool from humidity and direct sunlight. Only place fully charged batteries in storage (charged to at least 40%).
 8. Prevent the lithium-ion battery pack from freezing. Battery packs that were stored below 32°F (0°C) for more than 60 minutes must be discarded.
 9. When handling batteries, be wary of electrostatic charge. Electrostatic discharges can damage the electronic protection system and the battery cells. Avoid electrostatic charging and never touch the battery poles.

Protection from environmental influences

1. Wear suitable work clothes. Wear safety goggles.
2. Protect your cordless tool and the battery charger from moisture and rain. Moisture and rain can cause dangerous cell damage.
3. Do not use the cordless tool or the battery charger near vapors and flammable liquids.
4. Use the battery charger and cordless tools only in dry conditions and at an ambient temperature of 41°F – 105°F (5°C – 40.5°C).
5. Do not keep the battery charger in places where the temperature is liable to reach over 105°F (40.5°C). In particular, do not leave the battery charger in a car that is parked in the sunshine.
6. Protect batteries from overheating. Overloads, overcharging and exposure to direct sunlight will result in overheating and cell damage. Never charge or work with batteries that have been overheated – replace them immediately, if possible.

Safety Symbols

The following table depicts and describes safety symbols that may appear on this product. Read, understand and follow all instructions on this tool before attempting to assemble and operate.

Symbols	Descriptions	Symbols	Descriptions
	READ THE OPERATOR'S MANUAL(S) – Read, understand and follow all instructions in the user manual(s) before attempting to assemble and operate.		SAFETY ALERT – Indicates a precaution, a warning or a danger.
	WARNING! Do not expose the unit to rain or wet conditions. Keep dry.		Risk of Injury. Use safety glasses, hearing protection and dust mask.
	Wear protective gloves and non-slip footwear when using the machine and handling debris.		Wear protective, slip-resistant footwear during operation to protect feet.
	DANGER! Keep hands away from blade.		Keep bystanders a safe distance away from the work area.
	Thrown objects and rotating blade can cause severe injury.		Only use battery charger indoors.

Know Your Cordless Hedge Trimmer

Read the owner's manual and safety rules carefully before operating your cordless hedge trimmer. Compare the illustration below to the actual unit in order to familiarize yourself with the location of the various controls and adjustments. Save this manual for future reference.

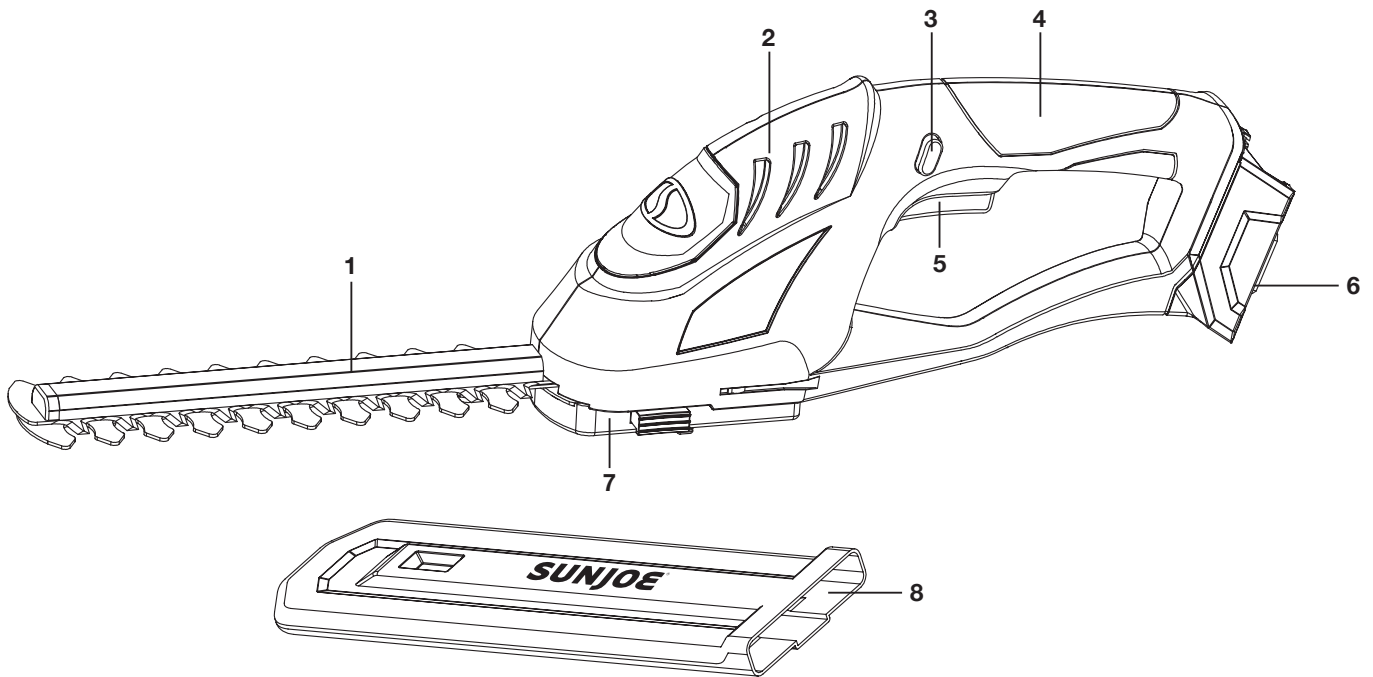

- | | |
|-------------------------|-------------------------------|
| 1. Hedge trimmer blades | 5. ON/OFF trigger switch |
| 2. Motor housing | 6. Battery compartment |
| 3. Safety lock button | 7. Blade cover |
| 4. Hedge trimmer handle | 8. Hedge trimmer blade sheath |

SOLD SEPARATELY

Battery + Charger options available at sunjoe.com



24VBAT-LTE

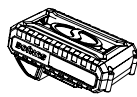

24VBAT-LT



24VBAT



24VBAT-XR



24VCHRG-QC

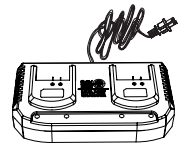

24VCHRG-DPC

Technical Data

Motor	60 Watt
Battery Voltage*	24V D.C.
Blade Length	7 in. (18 cm)
Blade Material	65Mn steel blades
Cutting Diameter Max	0.3 in. (7.8 mm)
No Load Speed	1150 rpm
Net Weight.....	1.8 lbs (0.8 kg)

**Initial no-load voltage, when fully charged, peaks at 24 volts; nominal voltage under typical load is 21.6 volts.*

Unpacking

Carton Contents

- Cordless hedge trimmer
- Hedge trimmer blades
- Hedge trimmer blade sheath
- Manual with registration card

NOTE: In order to operate this cordless hedge trimmer you will need iON+ 24V System batteries and chargers. See page 15 for battery options and specifications, or visit sunjoe.com.

1. Carefully remove the cordless hedge trimmer and check to see that all of the above items are supplied.
2. Inspect the product carefully to make sure no breakage or damage occurred during shipping. If you find damaged or missing parts, DO NOT return the unit to the store. Please call the Snow Joe® + Sun Joe® customer service center at 1-866-SNOWJOE (1-866-766-9563).

NOTE: Do not discard the shipping carton and packaging material until you are ready to use your new cordless hedge trimmer. The packaging is made of recyclable materials. Properly dispose of these materials in accordance with local regulations.

IMPORTANT! The equipment and packaging material are not toys. Do not let children play with plastic bags, foils or small parts. These items can be swallowed and pose a suffocation risk!

Battery Pack Operation

The equipment is powered by a lithium-ion battery. The battery pack is completely sealed and maintenance free.





TOOL ONLY BATTERY + CHARGER SOLD SEPARATELY

In order to operate this cordless hedge trimmer you will need an iON+ 24V System battery and charger. See page 15 for battery and charger options and specifications, or for more information visit sunjoe.com.

Battery Charge Level Indicator

The battery pack is equipped with a push button for checking the charge level. Simply press the push button to read off the battery charge level from the LEDs of the battery indicator:

- All 3 level monitoring LEDs are lit: Battery charge level is high.
- 2 level monitoring LEDs are lit: Battery charge level is decreasing. Stop work as soon as possible.
- 1 level monitoring LED is lit: Battery is flat. Stop work IMMEDIATELY and charge the battery. Otherwise the battery's service life will be greatly shortened.

Lights	Light Indicators
	Charge level button
	The battery is at 30% capacity and requires charging
	The battery is at 60% capacity and requires charging soon
	The battery is at full capacity

NOTE: If the charge level button does not appear to be working, insert the charger and charge as needed.

NOTE: Immediately after using the battery pack, the charge level button may display a lower charge than it will if checked a few minutes later. The battery cells "recover" some of their charge after resting.

Charger Operation

⚠️ WARNING! Charge only iON+ 24V lithium-ion battery packs with its compatible iON+ 24V lithium-ion quick charger. Other types of batteries may cause personal injury and damage. To reduce the risk of electric shock, do not allow water to flow into the charger's AC/DC plug.

TOOL ONLY
BATTERY + CHARGER SOLD SEPARATELY

In order to operate this cordless hedge trimmer you will need an iON+ 24V System battery and charger. See page 15 for battery and charger options and specifications, or for more information visit sunjoe.com.

When to Charge the iON+ 24V Lithium-iON Batteries

NOTE: The iON+ 24V lithium-ion battery packs do not develop a "memory" when charged after only a partial discharge. Therefore, it is not necessary to run down the battery pack before inserting the charger plug.

- Use the battery charge indicator lights to determine when to charge your iON+ 24V lithium-ion battery pack.
- You can "top-off" your battery pack's charge before starting a big job or after a long day of use.

Charging the Battery

1. Push the push lock buttons on the battery to pull the battery pack out from the battery compartment (Fig. 1).

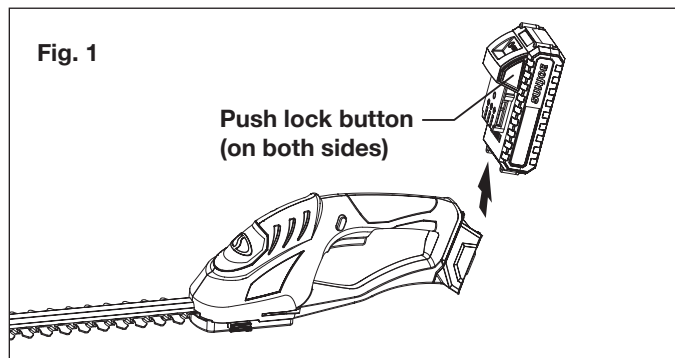

2. Depending on your Snow Joe® + Sun Joe® charger model, how to recharge your lithium-ion battery will vary. You may either insert your 24-volt battery into the 24VCHRG-QC Quick Charger (sold separately) or the 24VCHRG-DPC Dual Port Charger (sold separately) (Figs. 2 – 3).

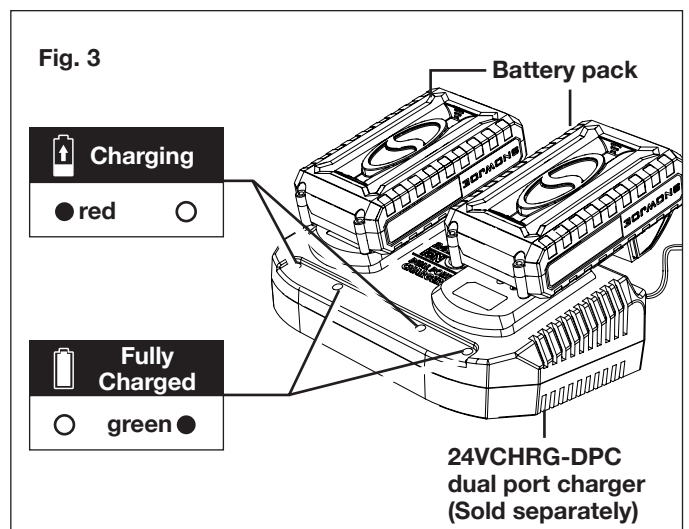
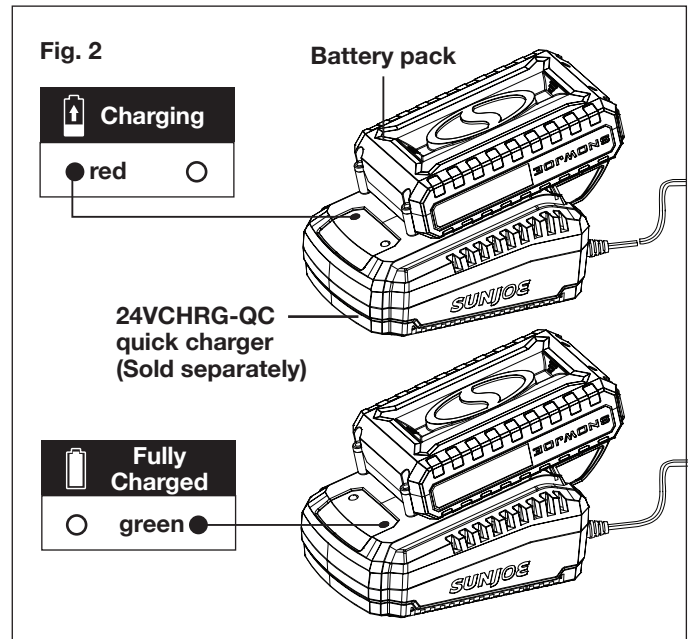

3. The battery indicator LEDs will illuminate one by one during the charging process. Unplug the charger immediately when the 3 LEDs are all illuminated.
4. The 24VCHRG-QC Quick Charger (sold separately) and the 24VCHRG-DPC Dual Port Charger (sold separately) are also equipped with additional charging indicating lights which will indicate the charging status (Figs. 2 – 3).

⚠️ CAUTION! FIRE HAZARD. When disconnecting the charger from the battery, be sure to unplug the charger from the outlet first, then disconnect the charger from the battery.

⚠️WARNING! This charger does not automatically turn off when the battery is fully charged. Please take care not to leave the battery plugged into the charger. Switch off or unplug the charger at the mains when charging is complete.

5. Timely recharging of the battery will help prolong the battery's life. You must recharge the battery pack when you notice a drop in the equipment's power.

IMPORTANT! Never allow the battery pack to become fully discharged as this will cause irreversible damage to the battery.

6. When charging is complete, remove the battery from the charger by pulling the push lock button and sliding the battery backward to unlock it from the charger.

Assembly

⚠️WARNING! Always remove battery pack from the tool when you are assembling parts, making adjustments, cleaning, or when not in use. Removing battery pack will prevent accidental starting that could cause serious personal injury.

⚠️WARNING! Do not use any attachments or accessories not recommended by the manufacturer of this product. The use of attachments or accessories not recommended can result in serious personal injury.

⚠️CAUTION! Wear protective gloves before handling the blades.

⚠️WARNING! Make sure the unit is powered off before handling the blades.

Fitting the Blades

1. To fit the blades, turn the unit upside down on a hard surface, align the blade cover tab with the slot in the motor housing and place it into position (Figs. 4 – 5)

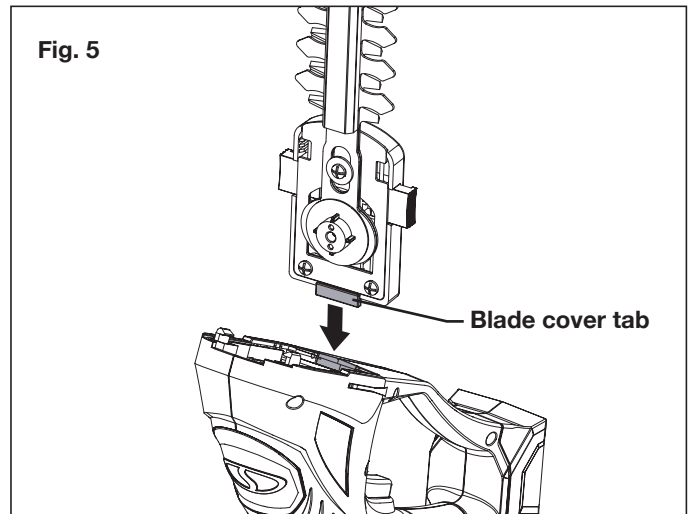
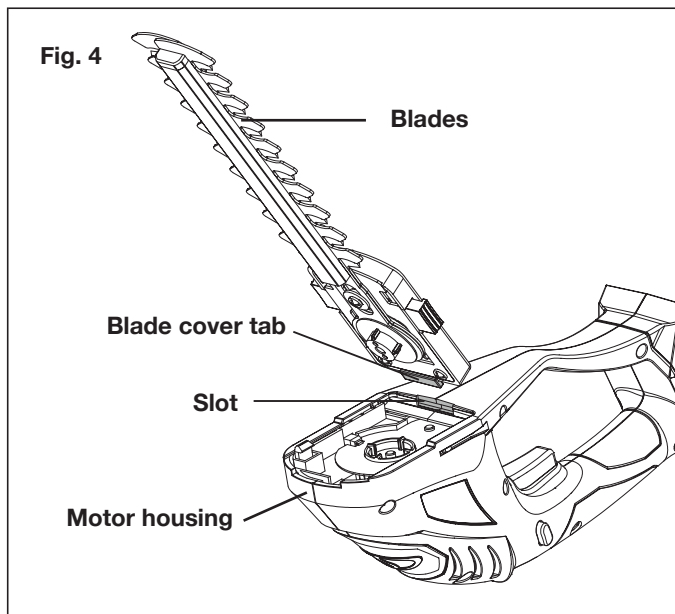

2. Place the blade cover down and make sure it clicks into place with the tabs on the motor housing (Fig. 6).

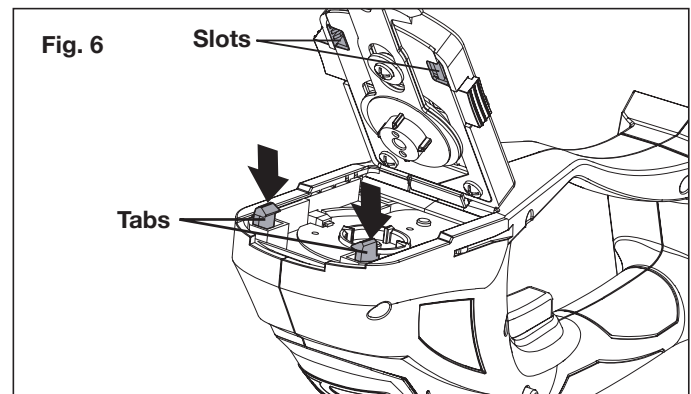

3. Make sure the latches on each side of the blade cover snap into place and that the blade is secured in the product before beginning operation (Figs. 7 – 8).

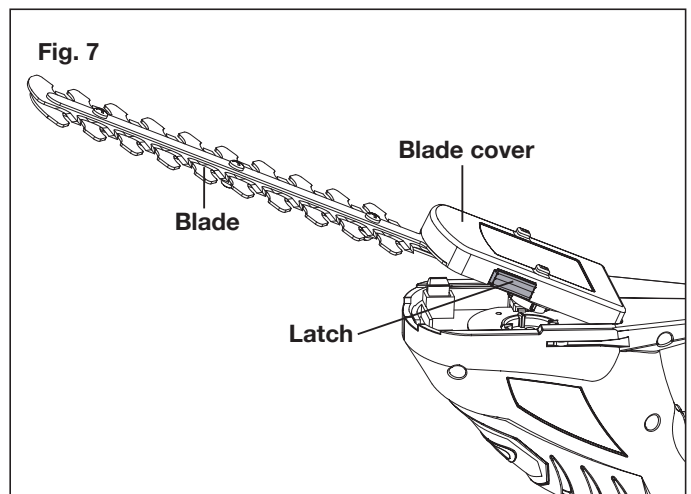
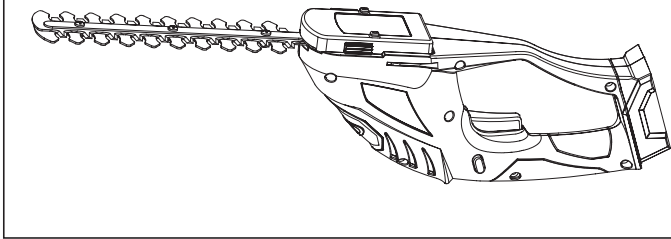

Fig. 8



4. To remove the blades, gently press the latches on both sides and lift the blades up (Fig. 7).

NOTE: If you have any questions, please call the Snow Joe® + Sun Joe® customer service department at 1-866-SNOWJOE (1-866-766-9563) for assistance.

Operation

IMPORTANT! The product is intended for light-duty trimming of shrubs for residential properties.

⚠WARNING! The blades continue to move for a few seconds after the tool is switched OFF. Turn OFF the tool and wait until the blades come to a complete stop before adjusting or cleaning.

⚠CAUTION! Never touch the blade or blade rail while the tool is in operation and be aware of the sharp edges even when the hedge trimmer is not in use.

TOOL ONLY BATTERY + CHARGER SOLD SEPARATELY

In order to operate this cordless hedge trimmer you will need an iON+ 24V System battery and charger. See page 15 for battery and charger options and specifications, or for more information visit sunjoe.com.

Starting + Stopping

1. Insert the battery fully in the battery compartment (Fig. 9).

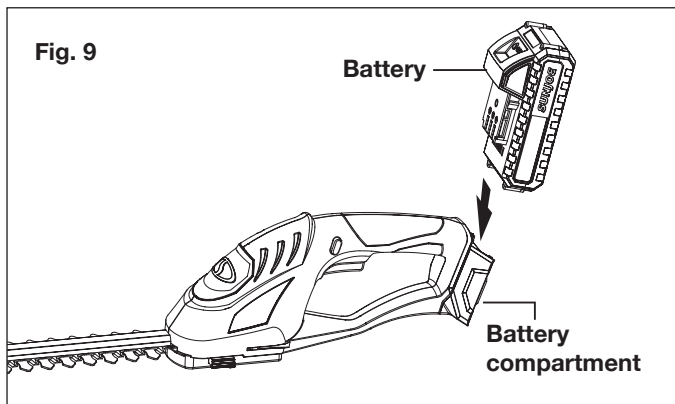

2. To power ON, push and hold the safety lock button with your thumb, while pressing the ON/OFF trigger switch with your forefinger. Once the trigger switch engages, you can release the safety lock button and proceed with operation (Fig. 10).

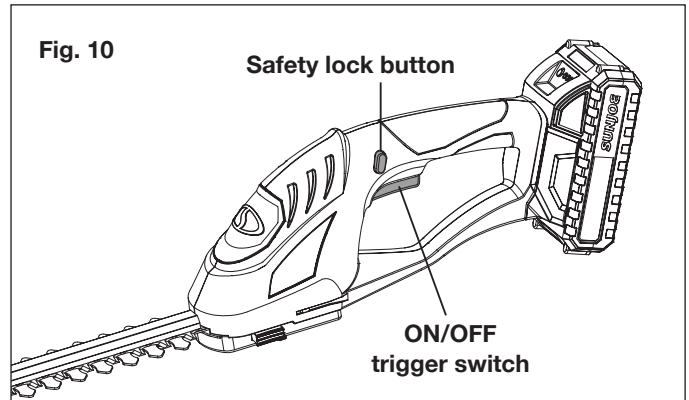

NOTE: The safety lock button reduces the risk of accidental starting.

3. To power OFF, simply release the ON/OFF trigger switch (Fig. 10).

⚠CAUTION! Do not force the blades through dense growth. If the blades slow down, then reduce your cutting pace. Should the blades jam, release the trigger immediately. Do not use your fingers to free up jammed blades. Jammed blades can release suddenly causing serious injury.

⚠CAUTION! Always ensure proper footing and balance in a clean and clear work environment before switching on the cordless hedge trimmer.

Trimming Tips

NOTE: Try to keep the cutting device angled at approximately 15° to the cutting surface (Fig. 11).

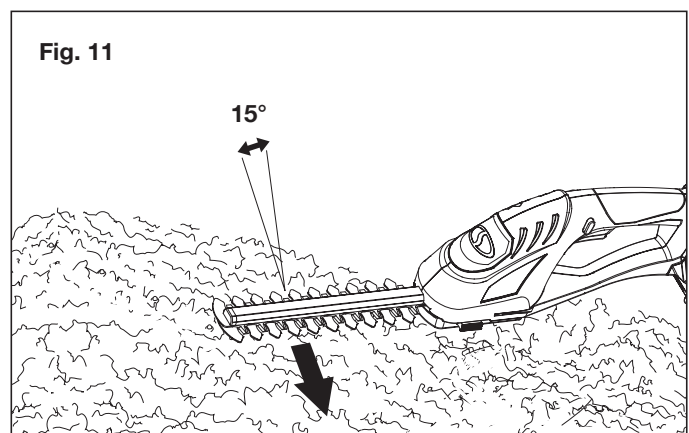

- 1. Shaping** – A hedge should be trimmed to achieve a trapezoidal form; it should widen toward the bottom on both sides. Shaping a hedge in this manner improves the penetration of light to the lower extremities. A general guideline is to slant the hedge approximately 4 in. (10 cm) for each 39 in. (1 m) of hedge height.
- 2. Cutting Sequence** – First cut both sides; start at the bottom and work towards the top. This prevents cuttings from falling into an area that you have yet to trim.
- 3. Trimming the Top** – Where the branches have grown extremely long, cut back the hedge in several stages. The shorter cuttings obtained are best suited for composting.
- 4. Pruning Thick Branches** – When older hedges are to be cut a substantial amount, use pruning shears or some other device to trim thicker branches (greater than 0.3 in. [8 mm] in diameter) to the desired length before starting work with the hedge trimmer.

To shape precisely, run a taught line between the extreme edges of the hedge and then trim along the length of the line.

Ensure that the blade does not come into contact with any object made of hard material that could damage it, such as fencing wire or metallic plant supports.

Maintenance

⚠WARNING! Always switch the product off and let the product cool down before performing inspection, maintenance and cleaning work.

1. Keep the ventilation vents of the tool clean at all times. If possible, prevent foreign matter from entering the vents.
2. If the enclosure of the trimmer requires cleaning, do not use solvents to clean it. Only use a moistened soft cloth. Never let any liquid get inside the tool; and never immerse any part of the tool into a liquid.
3. The blade rail should be cleaned and treated with light machine oil or spray lubricant (such as WD40, CRC 5.56 or RP7) after each use. When a job lasts for a long period of time, it is recommended that the blade rail also be treated with spray lubricant at regular intervals during operation.
4. Inspect the product before each use for worn and damaged parts. Do not operate it if you find broken and worn parts.

Blade Maintenance

To ensure years of efficient and trouble-free operation, blade cleaning should be performed if sap and debris have built-up, or if you live in an area where the soil is sandy. Cleaning unusually heavy deposits may require removal of the blades.

NOTE: Snow Joe® + Sun Joe® will not be held responsible for any damage or injuries caused by repair of the trimmer by an unauthorized person or by mishandling of the trimmer.

1. Keep the cutting blades clean and free of debris. Remove trimmings.
2. Apply a small amount of suitable lubricant on the blades to retain a good cutting performance (Fig. 12).

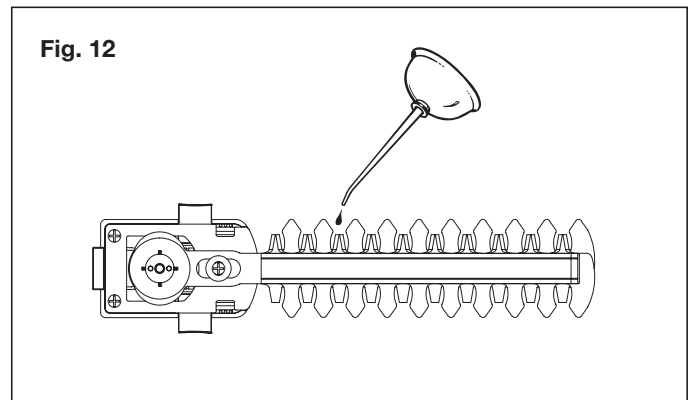

3. Keep the blades sharp. Replacement blades may be ordered online at sunjoe.com or via phone by contacting the Snow Joe® + Sun Joe® customer service center at 1-866-SNOWJOE (1-866-766-9563).

Storage

When the tool will not be used for several months, for optimal storage, proceed as follows:

- Fully charge the battery.
- Clean the product as describe above.
- Assemble the blade cover over the blades (Fig. 13).

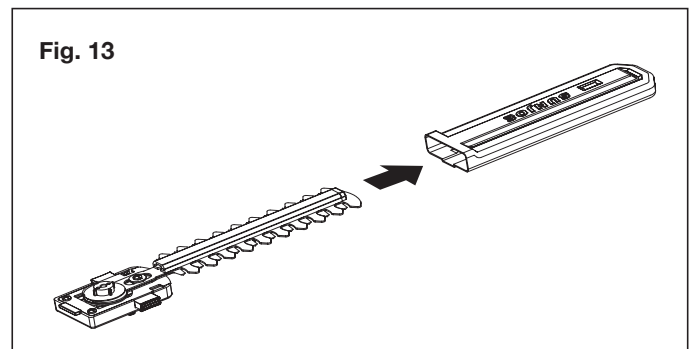

- Store the tool in a secure and dry location. The storage temperature must always remain in the range of 41°F (5°C) to 104°F (40°C).
- Before using the tool after prolonged storage, fully recharge the battery.

Battery Caution + Disposal

Always dispose of your battery pack according to federal, state, and local regulations. Contact a recycling agency in your area for recycling locations.

⚠ CAUTION! Even discharged battery packs contain some energy. Before disposing, use electrical tape to cover the terminals to prevent the battery pack from shorting, which could cause a fire or explosion.

⚠ WARNING! To reduce the risk of injury or explosion, never burn or incinerate a battery pack even if it is damaged, dead, or completely discharged. When burned, toxic fumes and materials are emitted into the surrounding atmosphere.

1. Batteries vary according to device. Consult your manual for specific information.
2. Install only new batteries of the same type in your product (where applicable).
3. Failure to insert batteries in the correct polarity, as indicated in the battery compartment or manual, may shorten the life of the batteries or cause batteries to leak.
4. Do not mix old and new batteries.
5. Do not mix Alkaline, Standard (Carbon-Zinc), or Rechargeable (Nickel Cadmium, Nickel Metal Hydride, or Lithium-Ion) batteries.
6. Do not dispose of batteries in fire. The cell of the battery may explode.
7. Batteries should be recycled or disposed of as per state and local guidelines.

Service + Support

- Hedge trimmer service must be performed only by qualified repair personnel. Service or maintenance performed by unqualified personnel may result in a risk of injury.
- When servicing the hedge trimmer, use only identical replacement parts. Follow instructions in the cleaning and maintenance section of this manual. Use of unauthorized parts or failure to follow maintenance instructions may create a risk of shock or injury.

- If your Sun Joe® cordless hedge trimmer requires service, contact an authorized Snow Joe® + Sun Joe® dealer or call the Snow Joe® + Sun Joe® customer service center at 1-866-SNOWJOE (1-866-766-9563).
- If the battery charger cable is damaged, it must be immediately replaced to avoid a hazard. Contact the Snow Joe® + Sun Joe® customer service center at 1-866-SNOWJOE (1-866-766-9563) for assistance.

Model + Serial Numbers

When contacting the company or reordering parts, you will need to provide the model and serial numbers of your product. These are found on the decal affixed to the housing or handle of your cordless hedge trimmer. Copy these numbers into the space provided below.

Record the following numbers from the housing or handle of your new product:	
Model #:	
2 4 V - S S E G - C T - R M	
Serial #:	

Optional Accessories

⚠️ WARNING! ALWAYS use only authorized Snow Joe® + Sun Joe® replacement parts and accessories. NEVER use replacement parts or accessories that are not intended for use with this cordless hedge trimmer. Contact Snow Joe® + Sun Joe® if you are unsure whether it is safe to use a particular replacement part or accessory with your cordless hedge trimmer. The use of any other attachment or accessory can be dangerous and could cause injury or mechanical damage.

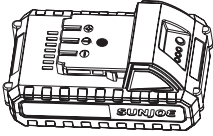
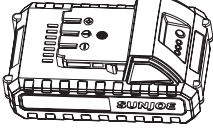
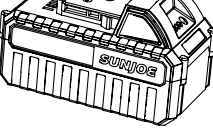
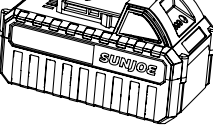
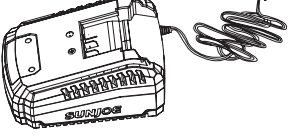
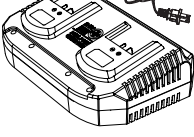
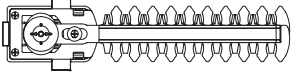
Accessories	Item	Model
	iON+ 24V 2.0 Ah Lithium-Ion Battery <i>Battery Runtime Max: 1 hr 20 min</i> <i>(cuts up to 1,990 sq. feet of hedges)</i>	24VBAT-LTE
	iON+ 24V 2.5 Ah Lithium-Ion Battery <i>Battery Runtime Max: 1 hr 40 min</i> <i>(cuts up to 2,475 sq. feet of hedges)</i>	24VBAT-LT
	iON+ 24V 4.0 Ah Lithium-Ion Battery <i>Battery Runtime Max: 2 hrs 40 min</i> <i>(cuts up to 3,980 sq. feet of hedges)</i>	24VBAT
	iON+ 24V 5.0 Ah Lithium-Ion Battery <i>Battery Runtime Max: 3 hrs 20 min</i> <i>(cuts up to 4,950 sq. feet of hedges)</i>	24VBAT-XR
	iON+ 24V Lithium-Ion Battery Quick Charger	24VCHRG-QC
	iON+ 24V Lithium-Ion Battery Dual Port Charger	24VCHRG-DPC
	Replacement Blades with Cover	SSEG-BLD

NOTE: Accessories are subject to change without any obligation on the part of Snow Joe® + Sun Joe® to provide notice of such changes. Accessories can be ordered online at sunjoe.com or via phone by contacting the Snow Joe® + Sun Joe® customer service center at 1-866-SNOWJOE (1-866-766-9563).

NOTES



SNOW JOE® + SUN JOE® REFURBISHED GOODS WARRANTY

GENERAL CONDITIONS:

Snow Joe® + Sun Joe® operating under Snow Joe®, LLC warrants this refurbished product to the original purchaser for 90 days against defects in material or workmanship when used for normal residential purposes. If a replacement part or product is needed, it will be sent free of charge to the original purchaser except as noted below.

The duration of this warranty applies only if the product is put to personal use around the household. It is the owner's responsibility to correctly perform all maintenance and minor adjustments explained in the owner's manual.

HOW TO OBTAIN YOUR REPLACEMENT PART OR PRODUCT:

To obtain a replacement part or product, please visit snowjoe.com/help or email us at help@snowjoe.com for instructions. Please be sure to register your unit beforehand to speed up this process. Certain products may require a serial number, typically found on the decal affixed to the housing or guard of your product. All products require a valid proof of purchase.

EXCLUSIONS:

- Wearing parts like belts, augers, chains and tines are not covered under this warranty. Wearing parts can be purchased at snowjoe.com or by calling 1-866-SNOWJOE (1-866-766-9563).
- Batteries are covered in full for 90-days from the date of purchase.

Snow Joe® + Sun Joe® may from time to time change the design of its products. Nothing contained in this warranty shall be construed as obligating Snow Joe® + Sun Joe® to incorporate such design changes into previously manufactured products, nor shall such changes be construed as an admission that previous designs were defective.

This warranty is intended to cover product defects only. Snow Joe®, LLC is not liable for indirect, incidental or consequential damages in connection with the use or misuse of the Snow Joe® + Sun Joe® products covered by this warranty. This warranty does not cover any cost or expense incurred by the purchaser in providing substitute equipment or service during reasonable periods of malfunction or non-use of this product while waiting for a replacement part or unit under this warranty. Some states do not allow exclusions of incidental or consequential damages so the above exclusions may not apply in all states. This warranty may give you specific legal rights in your state.

HOW TO REACH US:

We're here to help Monday through Friday from 9AM to 7PM EST and Saturday and Sunday 9AM to 4PM. You can reach us at 1-866-SNOWJOE (1 866-766-9563), online at snowjoe.com, via email at help@snowjoe.com or tweet us @snowjoe.

EXPORTS:

Customers who have purchased Snow Joe® + Sun Joe® products exported from the United States and Canada should contact their Snow Joe® + Sun Joe® distributor (dealer) to obtain information applicable to your country, province or state. If for any reason, you are not satisfied with the distributor's service, or if you have difficulty obtaining warranty information, contact your Snow Joe® + Sun Joe® seller. If in the event your efforts are unsatisfactory, please reach out to us directly.



sunjoe.com